

# Metron Medical Australia Pty Ltd

A.C.N.050 240 527

P.O. Box 2164,

57 Aster Avenue

Carrum Downs Victoria Australia 3201

Tel: (03) 9775 1234 Fax: (03) 9775 1990

Int: 61 3 9775 1234 Int: 61 3 9775 1990

## OPERATOR'S MANUAL

### METRON ACCUSONIC PLUS ULTRASOUND THERAPY UNIT

MODEL AP 100

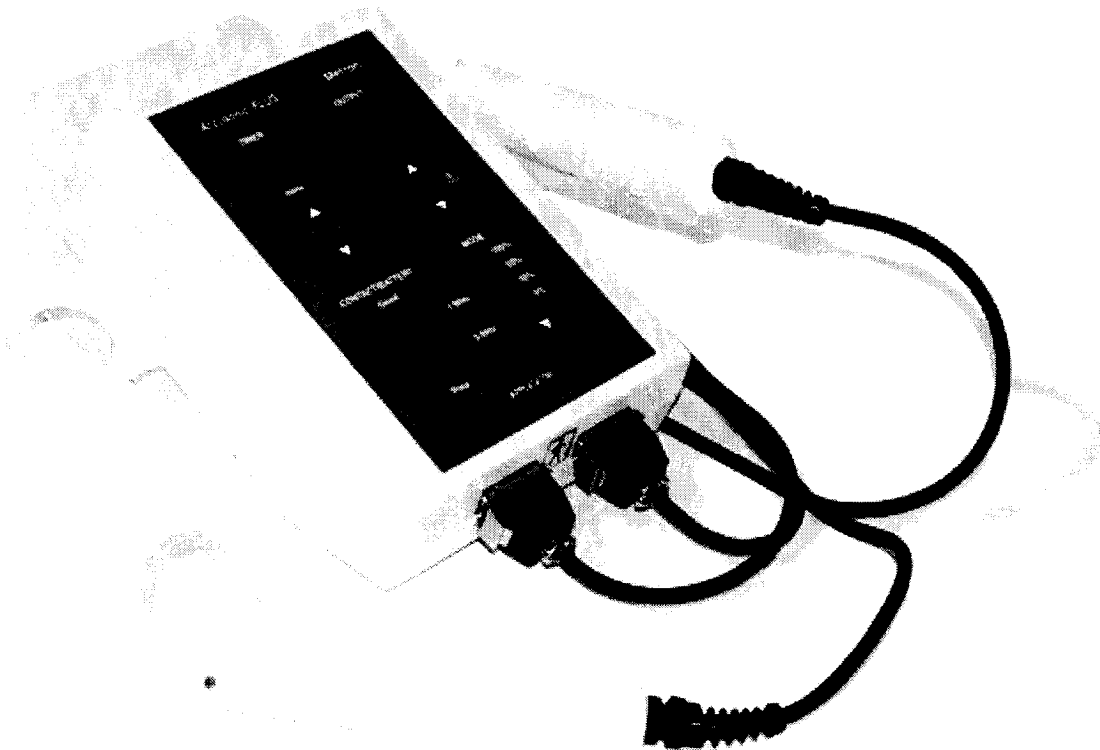

Prepared by

Metron Medical Australia P/L

Version 1.8 April 2002

## CONTENTS

<u>Section</u>	<u>Page</u>
1 Specifications .....	1
2 Introduction .....	3
3 Quality Assurance .....	3
4 Operating Warnings .....	4
4.1 Indications for Use .....	4
4.2 Contraindications .....	4
4.3 Precautions .....	4
4.4 Electromagnetic Interference .....	5
4.5 Inflammable Gases & Anaesthetics .....	5
4.6 Open Wounds or Broken Skin .....	5
4.7 Prevention of Cross Infection .....	5
4.8 Handling of Treatment Applicators .....	5
4.9 Damage to the Therapy Device .....	5
4.10 Interchangeable Treatment Applicators .....	6
5 Operating Instructions .....	7
5.1 Front Panel - Controls and Indicators .....	7
5.2 Front Panel - Functions of Controls and Indicators .....	8
5.2.1 Applying Mains Power to the Unit .....	8
5.2.2 Treatment Timer .....	8
5.2.3 Mode Switch .....	8
5.2.4 Ultrasound Output .....	9
5.2.5 Contact Sensing .....	10
5.2.6 Applicator Selection .....	10
5.2.7 Beam Pattern .....	10
5.3 Rear Panel .....	11
5.3.1 Mains Fuses .....	12
5.3.2 Mains Inlet Connector .....	12
5.3.3 Equipment Identification Labels .....	12
5.3.4 External Stimulator Connector .....	12
5.4 Symbols .....	12
5.5 Cleaning and Preventative Maintenance .....	13
5.5.1 Cleaning - Unit and Treatment Applicators .....	13
5.5.2 Preventative Maintenance .....	13
5.6 Treatment Applicators .....	13
5.6.1 General .....	13
5.6.2 1 MHz Applicator .....	13
5.6.3 3 MHz Applicator .....	14
6 Ultrasonic Therapy .....	15
6.1 Introduction .....	15
6.2 What Is Ultrasound? .....	15
6.3 How are Ultrasound Waves Generated? .....	15
6.4 How do Ultrasound Waves Act? .....	16
6.5 Is There any Hazard in Ultrasonic Therapy? .....	16
6.6 What are the Contraindications for Ultrasonic Therapy? .....	16
6.7 When is Pulsed Ultrasound Administered? .....	17
6.8 Method and Techniques of Ultrasonic Therapy .....	17
6.8.1 Patient - Applicator Contact .....	17
6.8.2 Underwater Treatment .....	17
6.8.3 Massaging or Static Sounding .....	18
6.8.4 Pulsed Ultrasound .....	18
6.9 Ultrasound Dosage .....	18
6.9.1 Rules for Ultrasound Dosage .....	19
6.9.2 Pulsed Ultrasound Dosage .....	19
6.10 3 MHz Versus 1 MHz Ultrasound .....	20
7 References .....	22
Warranty Statement .....	23
Declaration of Conformity .....	24
Authorised Representative .....	25

## 1. SPECIFICATIONS

### MAINS SUPPLY REQUIREMENTS:

Voltage	110/220/240 Volts AC
Frequency	50/60 Hz
Power	65 VA

### FUSES:

Primary external	2 of 1 A 5 x 20 mm DA205 Delay
Secondary internal	1 of 4A 5 x 20 mm M205

### MAINS STEP-DOWN TRANSFORMER:

Integrated switchmode power supply complying with international standard IEC 601-1: 1988 (EN 60601-1) and all subsequent amendments.

Secondary voltages	24 Volts @ 2.7A
--------------------	-----------------

### ULTRASOUND OUTPUT:

Frequency	1.1 MHz +/- 10%
Output intensity in continuous mode	3.0 Watts/cm <sup>2</sup> +/- 20% maximum (Equivalent to 15 watts absolute)
Effective Radiating Area	Nominally 5.0 square cms +/- 20%
Frequency	3.3 MHz +/- 10%
Output power in continuous mode	3.0 Watts/cm <sup>2</sup> +/- 10% maximum (Equivalent to 2.4 watts absolute for the 1cm head) 1.6 Watts/cm <sup>2</sup> +/- 10% maximum (Equivalent to 8.0 watts absolute for the 2.5 cm head)
Effective Radiating Area	Nominally 0.8 square cms +/- 20% (1 cm head) Nominally 5.0 square cms +/- 20% (2.5 cm head)
Power/intensity display	accurate to +/- 20% of reading for output in excess of 0.2 Watt/cm <sup>2</sup> .

<b>Beam Non-Uniformity Ratio</b>	Nominally 5:1 +/- 20%
----------------------------------	-----------------------

### **Ultrasound Modulation**

Modulation modes	continuous or pulsed
------------------	----------------------

#### Pulsed modulation:

Pulse frequency	100 Hz +/- 2%
Pulse period	10 milliseconds +/- 2%
Pulse width	1.0, 2.0, 5.0 milliseconds +/- 2%
Pulse duty cycle	1:9 (10%), 1:4 (20%), 1:1 (50%) respectively +/- 2%

**Treatment Timer**

Maximum treatment time 30 minutes +/- 2%  
 At time expiration time display shows zero and a two second audible alarm sounds.

**Contact Display**

Function displays the degree of contact being made to the patient by the treatment applicator. Loss of contact, which activates the contact control feature, occurs at approximately 25% of full scale.

**Contact Control**

Function to detect poor acoustic coupling between ultrasonic treatment applicator and patient detected.

At detection of contact loss the indicator on applicator illuminates red and after 1 second the treatment timer is halted, treatment time display flashes and ultrasonic output power is reduced from that selected to 1 Watt for 1MHz and 0.2 Watt for 3MHz.

At detection of contact the treatment timer is restarted and ultrasonic output power is restored to the selected value.

Purpose/rationale to ensure the patient receives the required ultrasound dose and to prevent damage to ultrasonic treatment applicator by the heat generated in ultrasonic transducer if it was operated unloaded.

**ELECTRICAL SAFETY:**

Manufactured to Australian Standards:

AS 3200.1 (1990) - Approval and Test Specification Medical Electrical Equipment  
 Part 1: General Requirements (direct reprint of IEC 601-1: 1998)  
 AS 3211 (1986) - Approval and Test Specification Ultrasonic Therapy Equipment

Applied Parts: Treatment applicators  
 Applied Parts Classification: BF  
 Device Classification: Class I Equipment

**DIMENSIONS:**

Width 170 mm  
 Height 120 mm  
 Depth 280 mm

**WEIGHT:**

Packed 3 Kg  
 Unpacked 2.5 Kg

**ENVIRONMENTAL CONDITIONS:**

**Operating:** Temperature Range 10 - 40 °C  
 Relative Humidity 30% - 90%

**Transport & Storage:** Temperature Range 0 - 70 °C  
 Relative Humidity 10% - 100%

## **2. INTRODUCTION**

Congratulations on the purchase of a Metron Accusonic Plus Ultrasonic Therapy Unit. We are confident that it will provide many years of excellent performance.

This Operator's Manual presents all the relevant operator information for the Metron Accusonic Plus Ultrasonic Therapy Unit. Refer to the Metron Accusonic Plus Technical Manual for maintenance, calibration and repair information.

The Accusonic Plus is a microcomputer controlled instrument. It comprises of the control unit and the ultrasonic treatment applicator/s. The control unit generates an electrical signal which is applied to an ultrasonic transducer. The ultrasonic transducer, bonded to the inside of the treatment applicator, converts the electrical signal into sound energy. This energy radiates from the flat applicator surface via acoustic coupling gel into the patient.

The control unit provides for operator setting of treatment time, continuous/pulse modulation modes and ultrasound output intensity. When used at 1MHz or 3MHz a contact control circuit monitors the integrity of acoustic coupling between the ultrasonic treatment applicator face and patient. If poor acoustic coupling is detected, the operator is alerted visually by illumination of the red warning light, the treatment time is halted and the ultrasound power is reduced to 1 Watt for 1MHz and 0.2 Watts for 3MHz. If good acoustic coupling is detected, the red light turns green, the treatment time counts down and ultrasound power is maintained until the timer displays zero. This feature ensures that the patient receives the required ultrasound dose and prevents damage to the ultrasonic treatment applicator by heat generated in the ultrasonic transducer when it is operated unloaded at high power levels.

## **3. QUALITY ASSURANCE**

It is recommended that a program of regular and appropriate quality assurance including calibration and electrical safety inspections be instituted for this equipment. Calibration should be performed at 12 month intervals. Information on the type and frequency of electrical safety testing may be obtained from locally published Standards.

In Australia, the relevant Standards published by the Standards Australia are:

- AS 2500 (1986) - Guide to the Safe Use of Electricity in Patient Care
- AS 3200.1 (1990) - Approval and Test Specification, Medical Electrical Equipment, Part 1: General Requirements
- AS 3211 (1986) - Approval and Test Specification, Ultrasonic Therapy Equipment
- AS 3551 (1988) - Acceptance Testing and In-Service Testing, Electromedical Equipment

A hospital Biomedical Engineering Department or a third party service organisation nominated by the manufacturer or distributor should be capable of performing the necessary calibration, testing and documentation. A program of electrical safety inspections is recommended to confirm continued operator and patient safety. Local statutory requirements for electrical safety inspections may also apply.

## **4. OPERATING WARNINGS**

### **4.1 Indications For Use**

The indications for use of this device are:

1. Relief or reduction of pain.
2. Reduction of muscle spasm.
3. Joint contracture.
4. Local increase in circulation

### **4.2 Contraindications**

Contraindications for use of ultrasound include:

1. Over or near bone growth centers until bone growth is complete.
2. Over the thoracic area if the patient is using a cardiac pacemaker.
3. In an area of the body where a malignancy is known to be present.
4. Over a healing fracture.
5. To the eye.
6. Over the pregnant uterus.
7. Over ischemic tissues in individuals with vascular disease where the blood supply would be unable to follow the increase in metabolic demand and tissue necrosis might result.
8. In the region of the reproductive organs.

### **4.3 Precautions**

Precautions should be taken when used:

1. Over an area of the spinal cord following a laminectomy, i.e. when major covering tissues have been removed.
2. Over anaesthetic areas.
3. On patients with haemorrhagic diatheses.
4. Over areas where metal prosthesis or other metallic implants are embedded in tissue which may form a reflective surface to the ultrasound energy causing unintended irradiation of tissue and excessive heating.
5. With high dosage levels because tissue damage may occur from excessive dosage. Periosteal pain is an indication of excessive ultrasound intensity. If this occurs, the applicator should be moved more quickly, the bony prominences avoided or the ultrasound intensity reduced.

#### **4.4 Electromagnetic Interference**

The Accusonic Plus has been designed to comply with IEC 601-1-2: 1993 but this does not guarantee that other equipment in the vicinity will not be affected by the electromagnetic emissions from this unit. Similarly, other equipment in the vicinity may effect the operation of the Accusonic Plus.

It is recommended that all equipment used near this unit complies with the relevant electromagnetic compatibility requirements for that equipment and to check before use that no interference is evident or disruptive. Increasing the distance between offending devices, and keeping interconnecting leads as short as possible will help reduce the effect.

#### **4.5 Inflammable Gases and Anaesthetics**

The Accusonic Plus is **NOT SUITABLE** for use in the presence of inflammable gases and anaesthetics.

#### **4.6 Open Wounds or Broken Tissue**

The Accusonic Plus treatment applicators have not been designed to be used on open wounds or broken skin. Use in the presence of these conditions is not recommended and is not an intended use of the device.

#### **4.7 Prevention of Cross Infection**

Even though the patient treatment applicators do not contact open wounds or broken skin it is still possible for them to carry infections by the mere fact that they contact bare skin.

The applicators should be thoroughly cleaned after a treatment session with one patient is completed prior to a new session beginning with another patient. The treatment applicators are not suitable for autoclaving. See Section 5.6 for more specific cleaning details.

#### **4.8 Handling of Treatment Applicators**

The treatment applicator encloses a delicate ceramic crystal. Rough handling, jarring or dropping may adversely affect the output performance of the Accusonic Plus. Careful handling of the applicator will prolong its life and preserve its output characteristics.

#### **4.9 Damage to the Therapy Device**

If when the unit is unpacked, or if it is mishandled at any stage of its life, and there appears to be physical damage to the machine it should not be used. Use should only commence or continue after it has been thoroughly checked by an appropriately qualified technician to ensure its functional and safety performance has not been impaired.

#### **4.10 Interchangeable Treatment Applicators**

The Accusonic Plus is designed to have interchangeable treatment applicators. To prevent possible damage to sensitive circuitry and potential malfunction applicators should only be connected or removed from the unit with the power turned "OFF".



## 5. OPERATING INSTRUCTIONS

**CAUTION:** Use of controls or adjustments or performance of procedures other than those specified herein may result in hazardous exposure to ultrasound energy.

### 5.1 Front Panel - Controls and Indicators

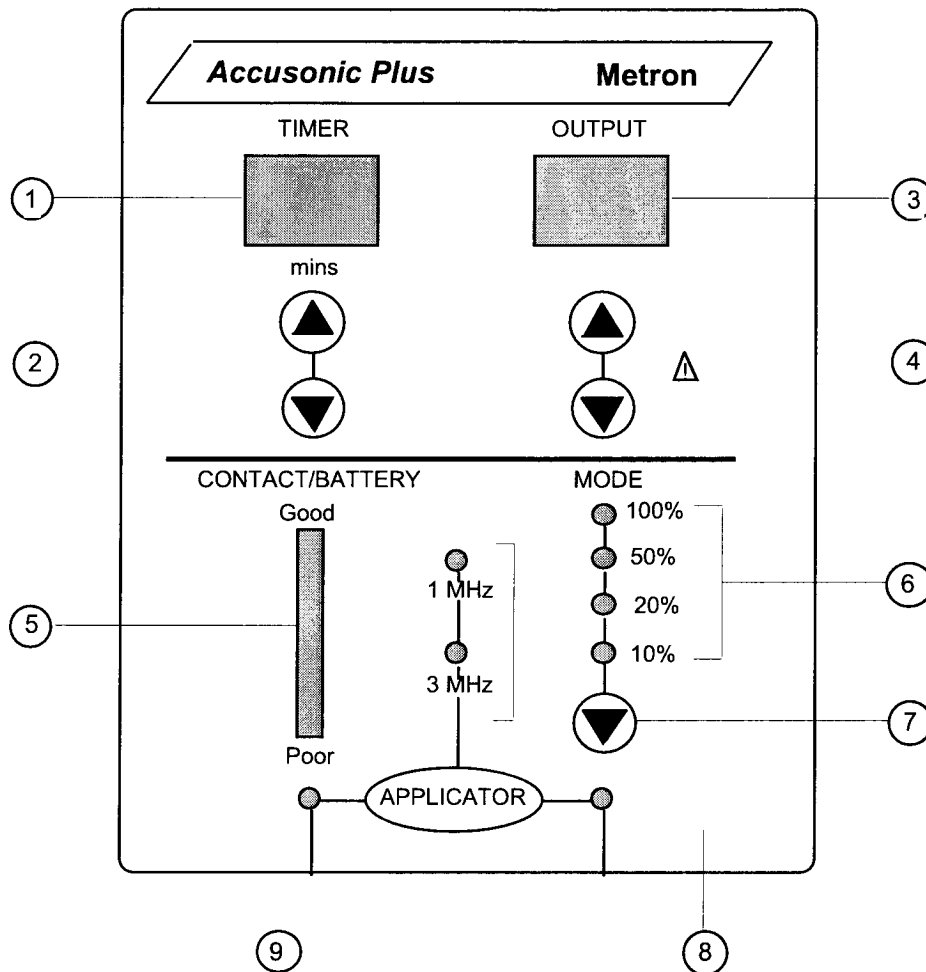

- |    |                               |    |                                  |
|----|-------------------------------|----|----------------------------------|
| 1. | Timer Display                 | 6. | Mode Indicators                  |
| 2. | Timer Up/Down                 | 7. | Mode Selector                    |
| 3. | Output Display                | 8. | Frequency Indicators             |
| 4. | Output Up/Down                | 9. | Applicator Selector & Indicators |
| 5. | Contact/Battery Level Display |    |                                  |

**Note** The following symbol is used on the front panel and is defined as follows:



This symbol indicates that the instructions for use should be consulted before operation is attempted.

## 5.2 Front Panel - Functions of Controls and Indicators

### 5.2.1 Applying Mains Power to the Unit

The mains power cord should be connected to mains power outlet and the outlet turned on. The Accusonic Plus does not have a power switch and has been designed to run from the mains power continuously. The unit has a sleep mode which means that after approximately 25 minutes of non-use the unit will automatically power down into the sleep mode. Alternatively the unit can be put into the sleep mode by actuating the "Mode" button continuously for 3 seconds.

To take the unit out of sleep mode the "Mode" button needs only to be actuated momentarily.

To completely isolate the Accusonic Plus from the mains supply the detachable power cord must be removed from the socket located on the rear panel.

This would be necessary for example to open the enclosure to perform service work.

### 5.2.2 Treatment Timer

When the power is switched on, the timer display is reset to zero. Each single, momentary depression of the timer switches causes the timer display to respectively count up or down in one minute steps. The maximum timer setting is 30 minutes. Continuous depression of either switch causes the timer display to continuously auto-count. The timer will cycle from 30 to zero minutes after counting up to 30 and from zero to 30 minutes after counting down to zero.

The timer will not proceed to count down until a non-zero ultrasound output is selected. When the treatment time expires, the timer display will show zero and a two second audible alarm will sound.

Once treatment is initiated the timer will count down in whole minutes until the last minute is reached at which point the count down changes to seconds.

### 5.2.3 Mode Switch (Continuous or Pulsed)

When the power is switched on, the modulation mode display is reset to "100%" (Continuous). Each single depression of the mode selector causes the modulation mode display to be cycled one place through the four selections available. The available modulation envelope selections are:

(a) "100%" - Continuous

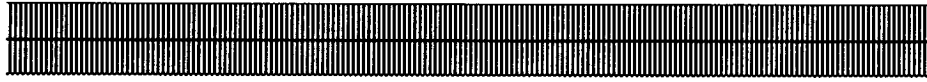

(b) "10%" - 1 ms ON/9 ms OFF, i.e. 1:9 duty cycle

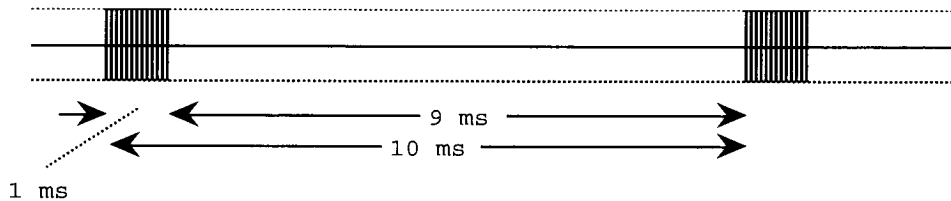

(c) "20%" - 2 ms ON/8 ms OFF, i.e. 1:4 duty cycle

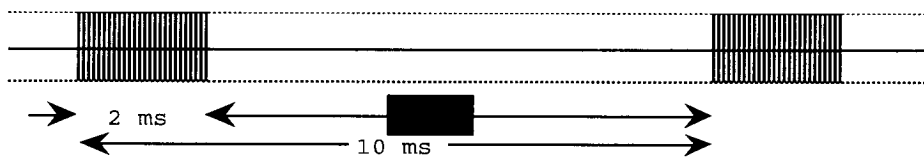

(d) "50%" - 5 ms ON/ 5 ms OFF, i.e. 1:1 duty cycle

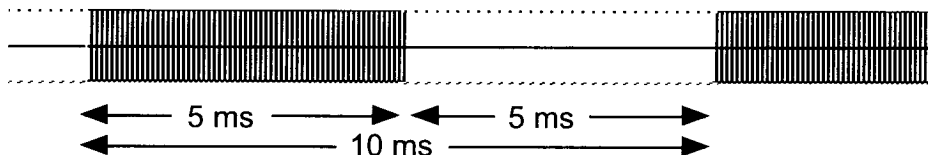

#### 5.2.4 Ultrasound Output

When the power is switched on, the output display is reset to zero. Each momentary depression of the output switches causes the output display to respectively count up or down in  $0.2 \text{ W/cm}^2$ . The maximum setting is  $3.0 \text{ W/cm}^2$  except for the 2.5 cm 3 MHz treatment applicator which has  $1.6 \text{ W/cm}^2$  as the maximum available. Holding down these switches causes the output display to continuously auto-count. The output will not cycle from maximum to zero when counting up nor from zero to maximum when counting down. This is a safety feature designed to prevent accidental selection of maximum ultrasound output.

The output display shows the ultrasound intensity in the continuous modulation mode: thus when pulse modulation is selected, the display does not change. When the ultrasound output is automatically reduced during contact loss, the display does not change.

### 5.2.5 Contact Sensing

The Accusonic Plus provides realtime monitoring of the level of acoustic power being delivered to the patient. This is displayed on the Contact Level Display, item 5 on the front panel layout on page 7. For the first time it is now possible for the therapist to monitor the level of acoustic power being delivered at any point in the treatment cycle. The bar graph basically covers the range from 100% down to approximately 40% of the output intensity setting. When the bar graph is no longer illuminated the acoustic power being delivered is less than 40% of the selected output setting. The contact sensing circuitry inhibits the output when this level drops to about 35% of the output setting. This is indicated by the LED on the treatment applicator turning RED and the "Timer" display flashing. When good contact has been reestablished the LED will turn GREEN and treatment will automatically recommence.

Experience gained from therapists employing this new feature has shown that to maintain effective treatment application technique may need to be modified. In particular gel may need to be applied during the treatment as well as at the start. This is because the gel disperses during treatment and this results in a degradation of the acoustic coupling between the patient and the applicator. This causes a lower level of acoustic power to be delivered to the patient. The necessity for additional gel applications is also very dependent on the body contour being treated and the size of the treatment applicator being employed.

The automatic inhibition of the output by the contact sensing circuit can be disabled, if desired, by the therapist. This can be done by pressing the "Power Up" and the "Power Down" buttons simultaneously and then turning the machine "ON". This will disable the contact sensing function for all future operation. Once disabled this feature can be re-enabled by repeating the above sequence of operations.

### 5.2.6 Applicator Selection

The applicators used on the Accusonic Plus can be connected to either input connector located at the front of the unit. Selection of the desired applicator is made with the "Applicator" switch. When a particular applicator is selected the Accusonic Plus automatically selects the correct operating frequency. The frequency set will be displayed by the frequency LEDs located immediately above the "Applicator" switch.

### 5.2.7 Beam Pattern

The beam produced by the applicator is classified as a collimated beam. This means that the beam is cylindrical in shape and is approximately constant in diameter as it moves away from the emitting surface of the applicator. This statement is valid for distances up to 25 cm from the emitting surface.

The beam intensity, if viewed as a cross-sectional slice taken through the cylinder, is bell shaped. The two plots below illustrate this point. The left hand plot was taken at 5 mm from the emitting surface and the right hand plot 125 mm from the emitting. The slight variations evident in the 5 mm plot are due to phase interactions that take place near the face of the applicator. The further from the applicator measurements are taken the smoother the intensity plot becomes.

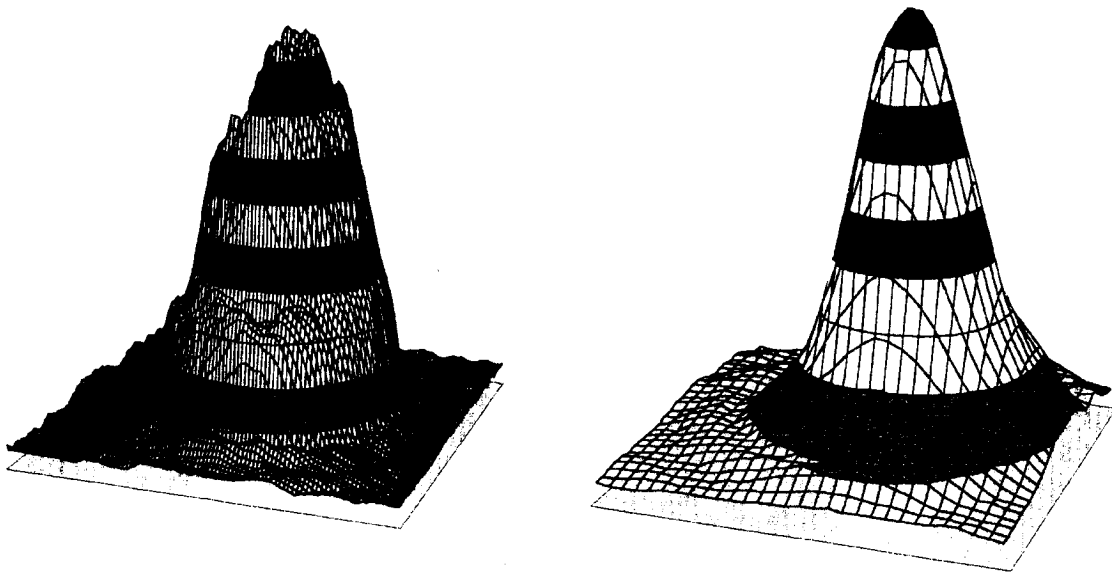

The beam non-uniformity ratio is a measure of the ratio of the maximum intensity measured over a small area anywhere in the beam profile to the average intensity over the entire beam. The Accusonic Plus has a beam non-uniformity ratio of 5:1.

### 5.3 Rear Panel

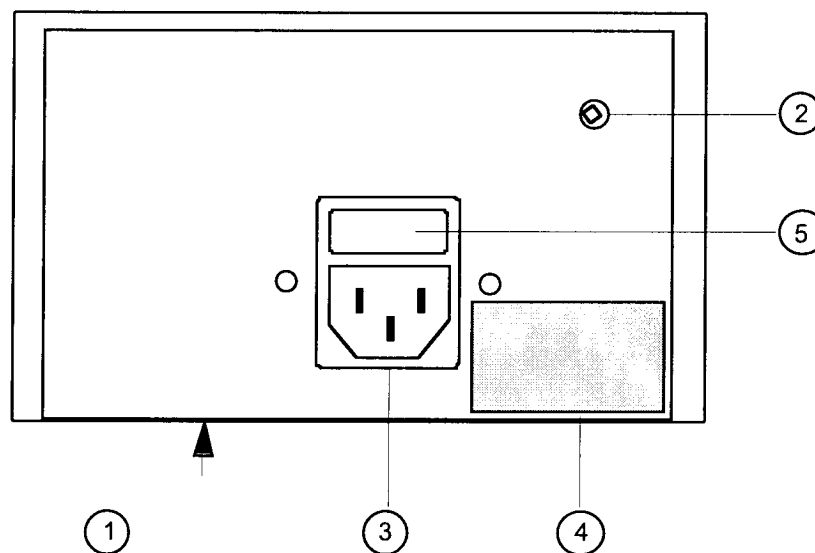

1. Equipment Identification Label (On bottom of case)
2. External Stimulator Connector
3. Mains Inlet Connector
4. Mains Supply Label
5. Mains Fuses 1Amp Delay

### 5.3.1 Mains Fuses

External mains fuses are installed to protect the Accusonic Plus from damage if certain internal faults occur. Fuses do age and sometimes fail unnecessarily. Fuse failure should not, however, be interpreted as a fault in the fuse only. If the mains fuses fail, the Accusonic Plus should be inspected by a qualified technician. Ensure that mains fuses are replaced with the same type and rating as stated on the equipment identification label.

### 5.3.2 Mains Inlet Connector

The mains inlet connector is an IEC appliance connection and contains the mains power switch and fuse holder. The mains cable supplied with the Accusonic Plus should be fitted with an approved plug suitable for connection to local mains power outlets. Ensure that the mains power outlet is properly earthed.

**IMPORTANT:** It is important that the Accusonic Plus be operated from a mains supply which has a nominal supply voltage equal to that indicated on the label on the rear panel. Safety and performance specifications are only valid if these voltages are the same.

### 5.3.3 Equipment Identification Label

This label is located on the bottom of the unit and provides information on the manufacturer, equipment identification and details of the ultrasound output.

### 5.3.4 External Stimulator Connector

This 2 mm socket provides direct electrical connection to the face plate of the treatment applicator. It allows the use of an external stimulator in conjunction with the application of ultrasound therapy. For this application the face plate of the treatment head becomes the active electrode for the stimulator. To complete the stimulator circuit another electrode will need to be connected to the patient.

Because this connection provides direct connection to the patient Metron recommends that only Metron stimulators be used for this application. This will ensure that the electrical safety of the patient is not compromised by the possible use of a stimulator not equipped with an isolated output.

## 5.4 Symbols

Several symbols are used on the enclosure of the Accusonic Plus which are defined as follows:



This symbol indicates that the instructions for use should be consulted before operation is attempted.

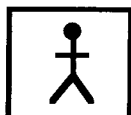

This symbol indicates that the applied parts (treatment applicators) of this equipment are rated as Type "BF" which means that the applied parts are suitable for placement on the external surface of the body.

## 5.5 Cleaning & Preventative Maintenance

### 5.5.1 Cleaning - Unit & Treatment Applicators

There is no requirement for routine cleaning of the Accusonic Plus other than to ensure that all ventilation holes are kept clear of debris and any spillage of conductive gels, etc, particularly on the front of the unit and near the mains inlet connector on the back of the unit be removed as soon as possible.

The treatment applicators should be kept free from gel buildup. Regular cleaning with a damp cloth soaked in a mixture of mild soap and water is recommended.

If there are concerns about cross infection the metal treatment surface of the applicator can be wiped with a surface disinfectant. Care should be taken not to contact the plastic parts of the treatment applicator with the disinfectant.

### 5.5.2 Preventative Maintenance

There is no preventative maintenance that needs to be performed on the Accusonic Plus other than occasional cleaning as detailed in clause 5.5.1 preceding. It is however recommended that routine calibration verification and electrical safety testing be carried out on the Accusonic Plus at least once every twelve months. Information on the type and frequency of electrical safety testing may be obtained from Australian Standard AS 3551 or from relevant locally published standards.

## 5.6 Treatment Applicators

### 5.6.1 General

The treatment applicator or applicators are connected to the unit via the two connectors located on the front edge of the unit. Any treatment applicator can be connected to either socket as the Accusonic Plus automatically recognises the type of treatment applicator when it is selected.

**Warning:** Treatment applicators should not be connected to or removed from the Accusonic Plus when it is turned "ON". Always turn the power "OFF" first.

### 5.6.2 1MHz & 3MHz 2.5 cm Applicators

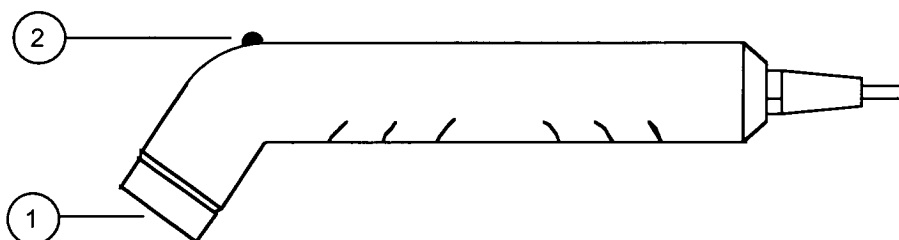

- 1. Circular face from which ultrasound radiates
- 2. Contact indicator:  
Green light indicates ultrasound power on / contact  
Red light indicates contact loss

5.6.3 3MHz 1.0 cm Applicator

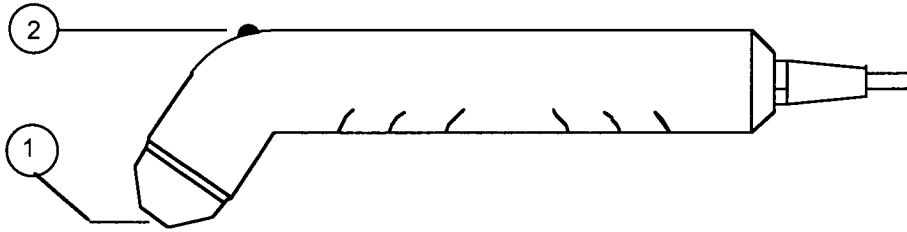

- 1. Circular face from which ultrasound radiates
- 2. Contact indicator:  
Green light indicates ultrasound power on / contact  
Red light indicates contact loss

$0.85 \text{ W/cm}^2$

settings		
1	⇒	0.8 W
2	⇎	1.6
3	⇒	2.4 W





## **6. ULTRASONIC THERAPY**

### **6.1 Introduction**

Ultrasonic therapy is an effective method of treating various ailments. The technique is simple and the treatment is safe to both patient and therapist, providing that reliable equipment is used.

Satisfactory results have been obtained in the treatment of neuritis, neuralgia, degenerative joint diseases, arthritis, indolent ulcer of the leg, acute inflammatory processes, prostatitis and angiospasm.

Although the medical applications of ultrasound are recent, the principles date back many years. Ultrasound was first used for underwater echo sounding in 1917 and the first biological effects were observed on fish. Since then, research into biological effects has produced a number of clinically important results.

Shortly before the Second World War, development and design of ultrasonic therapy units had progressed sufficiently to enable an extensive series of observations on human patients. In the years following, extensive studies of the biological effects of ultrasound were conducted. These fundamental studies laid the groundwork to ensure that modern ultrasonic therapy units can be used without hazard by a competent practitioner.

### **6.2 What Is Ultrasound?**

Depression of a piano key causes a hammer to strike a string which vibrates and produces sound waves. The human ear is sensitive to sound waves between the frequencies of 20 and 17,000 Hz (1 Hertz or Hz = 1 cycle per second). Sound waves with frequencies higher than the upper limit of hearing are described as ultrasound.

Ultrasound waves obey the same fundamental laws of acoustics as do sound waves: they therefore require some conducting medium. Ultrasound waves are suited to therapeutic applications because they can be beamed, like the light from a torch, and because of their ability to selectively heat deeply located tissue. Ultrasonic waves carry much greater energies than sonic waves of the same amplitude because of their high frequency. It is possible to generate ultrasonic waves of very high frequencies. For therapeutic purposes, the most effective frequencies are in the region of 1,000,000 Hz (1MHz) up to 3,000,000 (3MHz).

### **6.3 How Are Ultrasound Waves Generated?**

An ultrasonic therapy unit comprises two main parts; an electronic high frequency electrical signal generator and the ultrasonic treatment applicator. The high frequency electrical oscillations excite a piezoelectric transducer which oscillates mechanically producing ultrasonic waves which radiate from the ultrasonic treatment applicator (refer Ward (1986)).

The ultrasound frequency of the Metron Accusonic Plus Ultrasonic Therapy Unit is 1.1 MHz. In the continuous modulation mode at maximum intensity the average effective power is 3.0 Watts per square centimetre on either treatment applicator. The ultrasonic waves may be continuous or pulsed with pulse durations of 0.5, 1.0 and 2.0 milliseconds.

#### **6.4 How Do Ultrasound Waves Act?**

On the basis of present knowledge, the following physical actions can be cited as important factors in ultrasonic therapy:

- \* Generation of heat in tissue occurring by absorption of ultrasonic energy.
- \* Specific mechanical actions which are attributed to the forces associated with regions of alternating pressure separated by one half of a wavelength in tissue. This is sometimes described as a micro-massage effect.

In organisms these physical actions produce the following physiological effects:

- \* The blood and lymph supply of the tissues is considerably improved, much more than could be expected through superficial heating such as with infrared treatment or hot packs.
- \* Cellular metabolism is demonstrably increased by improved blood and lymph flow, mechanical vibration and heating.
- \* In inflamed tissue, acidity is returned more rapidly to normal.
- \* Spasms of pain are relieved through the action of ultrasound on the sympathetic nervous system.

#### **6.5 Is There Any Hazard In Ultrasonic Therapy?**

Every effective therapy, whether pharmacological or physical, has an inherent danger if not correctly applied or if administered by persons other than expert. Ultrasound energy can produce injury. When used correctly the Metron Accusonic Plus will not produce undesirable effects and treatment is entirely painless. The operator is not exposed to stray ultrasound radiation from the treatment applicator on the Metron Accusonic Plus. The treatment applicator is completely shielded with the exception of the circular face. No ultrasound radiates from the handle.

#### **6.6 What Are Contraindications For Ultrasonic Therapy?**

Operators are warned against the use of ultrasonic therapy:

- \* Near the heart.
- \* Over the eyes.
- \* Over the uterus during pregnancy.
- \* In the region of the reproductive organs.
- \* Directly over the spinal column (post-laminectomy), visceral plexi and large autonomic ganglia.
- \* Over areas of malignancy.
- \* Where the skin has no sensation.
- \* Over growing bone ends in children.

Operators are cautioned in the use of ultrasonic therapy:

- \* The applicator should be moved continuously over the treatment site throughout

- \* Areas where metal such as a prosthesis or pacemaker is embedded in tissue may form a reflective surface to the ultrasound causing unintended irradiation of tissue and excessive heating.
- \* Damage to tissue may occur from excessive ultrasound dosage. Periosteal pain is an indication of excessive ultrasound intensity. If this occurs, the applicator should be moved more quickly, the bony prominences avoided or the ultrasonic intensity reduced.

### **6.7 When Is Pulsed Ultrasound Administered?**

Ultrasound is an effective therapy when administered either in pulsed or in continuous mode. Pulsed ultrasound ensures the heat generated in tissue is minimised while most of the effect of micro-massage is obtained. Pulsed ultrasound is recommended in all cases where a high ultrasound intensity is indicated and where periosteal pain may occur. Investigations indicate that pulsed ultrasound is an invaluable technique in the treatment of the nervous system.

### **6.8 Method And Techniques Of Ultrasonic Therapy**

The following description of technique and dosage of ultrasound have been compiled from various reports, unpublished communications and from our own observations.

#### **6.8.1 Patient-applicator contact**

Good acoustic coupling between the ultrasonic treatment applicator and the treatment site is most important and is monitored by the Metron Accusonic Plus. Air is a poor conducting medium of ultrasound. A good ultrasonic conducting medium of acoustic coupling gel between the applicator and treatment site is essential for efficient transfer of ultrasonic energy. A liquid film of gel must be maintained between the applicator and the treatment site throughout the course of the therapy. During long periods of treatment, the gel should be renewed periodically. It is best to use too much rather than too little gel - estimation of the correct amount will come with experience. The applicator face should be kept parallel to the surface being treated.

#### **6.8.2 Underwater treatment**

Underwater treatment, although more complicated than direct treatment, affords many advantages in certain cases. It facilitates even and efficient sound transmission and is indicated where the surface to be treated is so uneven or small that good contact with the applicator can only be made with difficulty, or not at all. Underwater treatment can be used for treating small joints, areas of ulceration or areas sensitive to pressure.

In underwater treatment the part of the body concerned is immersed in a vessel filled with warm water. The water should always be degassed by boiling, a condition which frequently cannot be fulfilled in practice. In contrast with direct contact treatment, the applicator is held 1 to 5 cm or 0.5 to 2 inches from the body surface during underwater treatment. Treatment must be terminated as soon as bubbles are noticed adhering to either the skin or the applicator. The air in the bubbles is a poor conductor of ultrasound.

### 6.8.3 Massaging or static sounding

In massaging treatment the applicator is applied with moderate contact pressure and movement over the desired area. The applicator is held lightly between the fingers. Tight gripping will cause fatigue and turning of the applicator. The applicator should be moved as slowly as possible in order to maintain sufficient exposure. When moving over bony surfaces such as knees, the applicator should be moved sufficiently rapidly to ensure that the patient does not experience periosteal pain. Pulsed ultrasound is preferred for massaging treatment.

Massage should be administered with moderate pressure over the skin in a slow rhythmic manner with a pattern of movement which may have to be varied depending on the size and shape of the field to be treated. Stroking, with one stroke overlapping by half the width of the applicator is used. The stroke length is about 2.5 to 5 cm or 1 to 2 inches. The applicator is moved gradually in the direction perpendicular to the stroke in a field of about 25 to 100 square centimetres or 2 to 4 square inches at any one time. This technique has the advantage that the moving applicator provides for uniform heating. Also, if the field is not too large, the temperature increase resulting from the first movement of the applicator over an area is not dissipated when the applicator returns to the same place; thus, the temperature is gradually elevated to a therapeutically useful value. Moving the applicator in a spiral path with small overlapping circles, allows treatment of wider fields with relatively uniform distribution of the ultrasound. A rate of approximately one circle per second is suggested.

### 6.8.4 Pulsed ultrasound

Pulsed ultrasound differs from continuous ultrasound in that heat localisation and accumulation is avoided. It is suitable for high intensity treatment of a joint particularly when it lies close to the skin and where periosteal pain should be avoided and for heat sensitive neuritis and sensitive tissue.

## 6.9 Ultrasound Dosage

Estimation of ultrasound dosage is gained with experience. The following factors should be considered:

- \* Two important factors in dosage are the ultrasound intensity and the duration of treatment. The product (intensity x duration) determines the total ultrasound energy delivered. On this basis one might expect that a treatment at 1 Watt/cm<sup>2</sup> for 4 minutes would have the same effect as a treatment of 2 Watt/cm<sup>2</sup> for 2 minutes: this is not the case! A treatment of short duration at high intensity is not equivalent to a treatment of long duration at low intensity because of the heat dissipating mechanisms of biological tissue. Greater temperature elevation will result from the short duration, high intensity treatment. Ward (1986) chapters 8 and 10 discusses ultrasound dosage and effects.
- \* It is important to ascertain the smallest dose which will produce an optimum result. The treatment times and intensities quoted here are only general recommendations. The correct dosage for each case depends on the individual reaction to the therapy. Treatment should begin with smaller doses than those which seem to be indicated. Following are some simple guidelines for ultrasound dosage.

Further recommendations are to be found in Wadsworth and Chanmugam (1983), chapters 5 and 12.

### **6.9.1 Rules for ultrasound dosage**

Commence with an average intensity of 1 watt/cm<sup>2</sup> and an average treatment time of 3 to 4 minutes. Determine the correct dosage for the individual case according to the following three criteria:

\* Nature of disease -

Chronic, indolent processes generally tolerate and require a more massive action, i.e. a higher initial intensity and duration (treatment time) than acute conditions.

\* Seat of disease -

Due to adsorption, the ultrasound intensity decreases with depth. After penetrating a tissue layer of thickness 3.5 cm the intensity might have reduced to one half of its initial value (depending on the nature of the tissue). At a depth of 7 cm, the intensity would be reduced to a quarter of its initial value. Accordingly, a deep lesion in an obese patient will be treated with a higher initial intensity.

\* Area to be treated -

The larger the treated surface, the longer the exposure must be. This will provide sufficient energy for each area of treatment.

With any new therapeutic agent the matter of dosage receives considerable attention on the part of those who have done research and experimental work. In ultrasonic therapy the following general principles are well established:

- \* Pain is an indication of over dosage.
- \* Ultrasonic therapy is a safe procedure of dosage is kept below the pain threshold.
- \* A five minute treatment over a given area is normally sufficient.
- \* Therapeutic intensities of 0.5 to 3.0 Watts/cm<sup>2</sup> have been used with good results, the lower intensities in acute conditions and the higher in chronic.
- \* When ultrasound is applied to the nerve root area in addition to the affected area, the intensity over the nerve root area should not exceed 0.5 Watts/cm<sup>2</sup> and application should be made with a circular or stroking motion.

### **6.9.2 Pulsed ultrasound dosage**

When pulsed ultrasound is used, the total energy of the ultrasound is a fraction of that for continuous ultrasound by virtue of the same amplitude but reduced duty cycle. If no compensation is made for the energy loss due to the long interval between pulses, the heating of tissue will be much less. When a micro-massage effect is required with a minimum of heating, pulsed ultrasound treatment is indicated.

The short time of each pulse is sufficient to elicit a biological action and the time between pulses of less than 1/100th of a second (10 milliseconds) is short enough such that the biological response does not decay to zero. Before the biological reaction has diminished significantly, the next ultrasound pulse has been delivered and the treated area is restimulated.

### 6.10 3 MHz versus 1 MHz Ultrasound

When ultrasound travels through the human body, the amount of energy absorbed, and consequently the amount of heat produced, is different in different tissues. The rate of energy absorption is indicated by the penetration depth. A high penetration depth implies a low rate of energy absorption and a low penetration depth implies a high rate of energy absorption.

Ultrasound is therapeutically useful because of its high penetration depth in fatty tissue and lower penetration depth in muscle: ultrasound energy is absorbed at a greater rate in muscle and consequently the heating rate is higher.

The table below, taken from Ward (1986), shows the penetration depth of 1 MHz ultrasound and 3 MHz ultrasound in fat, muscle and bone tissues:

ultrasound frequency	penetration depth in fat	penetration depth in muscle	penetration depth in bone
1 MHz	22.0 cm	4.0 cm	0.058 cm
3 MHz	3.8 cm	1.1 cm	0.006 cm

It is clear from the table that in each tissue 1MHz ultrasound has a higher penetration depth than 3 MHz ultrasound. This means that 1 MHz ultrasound penetrates more deeply in tissue. It also means that the heat production in a given volume is less.

Values of penetration depth can be used to calculate the ultrasound energy and rate of heating at different depths in the body. The diagrams below show the calculated ultrasound intensity and pattern of relative heating in a tissue combination consisting of two centimetre layers of fat, muscle and bone.

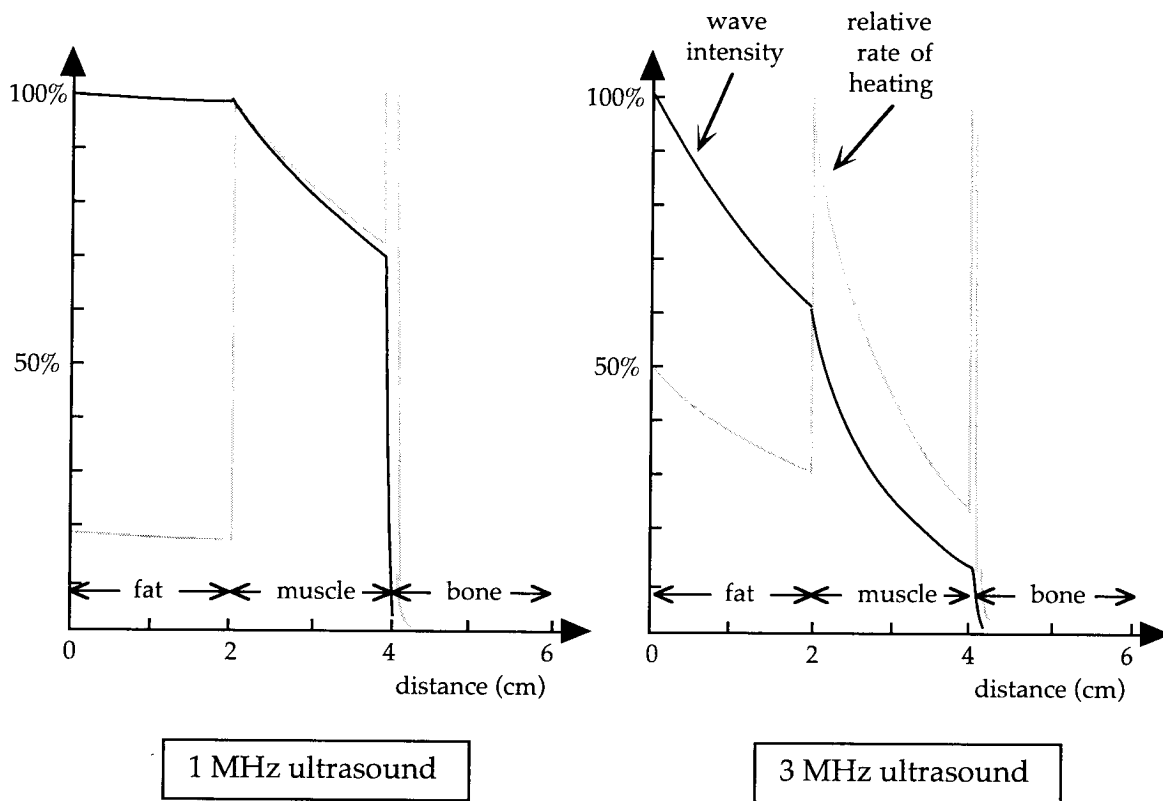

Consider first 1 MHz ultrasound. The ultrasound intensity drops very slowly in fatty tissue, resulting in a very low relative rate of heating. It is absorbed more rapidly in muscle, resulting in greater heating. The pattern of heating in the fat/muscle combination is therapeutically desirable but the heating rate of the superficial bone is not: here the rate of heating shows a sharp, intense peak. Although not shown on the diagram, the relative rate of heating is some forty times higher than in muscle. It is this which gives rise to periosteal pain and the risk of burns in the periosteum. The only way to avoid the problem is to keep the total ultrasound intensity low, which also reduces the effectiveness of heating of the fatty tissue and muscle layers.

At a frequency of 3 MHz, penetration depth values are lower in each tissue, resulting in more rapid absorption of ultrasound energy. Only a fraction of the wave energy remains to heat the bone and consequently the peak in the heating pattern in the superficial bone tissue is much smaller than with 1 MHz ultrasound. As the graph shows, a much higher percentage of the ultrasound energy is absorbed in the fatty tissue and muscle.

It is for this reason that 3 MHz ultrasound is preferred when treating soft tissue overlying bone in most regions of the body.

1 MHz ultrasound has the advantage when the soft tissue volumes are large as, for example, when the patient is large and obese or when treating bulky muscle groups such as the quadriceps of athletes. 3 MHz ultrasound is preferred when the fatty tissue and muscle layers are a few centimetres or less in thickness.

## 7. REFERENCES

Wadsworth, H. and Chanmugam, A.P.P., *Electrophysical agents in therapy*, Science Press (1983).

Ward, A. R., *Electricity, Fields and Waves in Therapy*, Science Press (1986).



## **WARRANTY STATEMENT**

Metron Medical Australia Pty Ltd., will warrant this device/instrument/appliance (excluding accessories) against defects in manufacture for a period of two years from the date of purchase.

Accessories including patient leads, cables and electrodes will be covered under this warranty for a period of three months from the date of purchase.

### **- PROVIDING -**

The instrument has not been serviced by persons not authorised by Metron Medical Australia Pty Ltd., and has not been misused or tampered with and has been used on the correct voltage as branded on it.

### **- THIS WARRANTY EXCLUDES -**

Parts of the device/instrument/appliance failure of which in the opinion of the dealer or manufacturer is a result of misuses or abuse or any other reason not directly attributed to fault in manufacture. Batteries are excluded from this warranty except where it can be demonstrated that any battery failure was caused by a malfunction in the Accusonic Plus. This warranty also excludes glass or ceramic portions.

### **- IN THE EVENT OF FAILURE -**

The complete device/instrument/appliance should be returned to the dealer from which it was purchased or to the nearest authorised service agent, together with a full report, freight paid and insured.

### **- UNDER NO CIRCUMSTANCES -**

Shall Metron Medical Australia Pty Ltd., or their agents or dealers be liable in any manner whatsoever for any compensation or damages to any person occasioned by this device/instrument/appliance for any loss, injury or any damage occasioned by or as a result of the misuse or abuse of this device/instrument/appliance.

### **- LOSS IN TRANSIT -**

The warrantor does not accept any responsibility for loss or damage to the device/instrument/appliance in transit.

Any express or applied conditions, statements or warranty, statutory or otherwise (save specifically provided above) is hereby excluded.

# Metron Medical Australia Pty Ltd

A.C.N.050 240 527

**P.O. Box 2164,**

**57 Aster Avenue**

**Carrum Downs Victoria Australia 3201**

Tel: (03) 9775 1234 Fax: (03) 9775 1990

Int: 61 3 9775 1234 Int: 61 3 9775 1990

## EC DECLARATION OF CONFORMITY

Metron Medical Australia Pty Ltd  
57 Aster Avenue  
Carrum Downs, Australia, 3201

declares that the medical devices described hereafter:

### **Metron Accusonic Plus Ultrasound Therapy Unit**

**Model: AP 100**

is in conformity with the essential requirements and provisions of Council Directive 93/42/EEC

is subject to the procedure set out in Annex II of Directive 93/42/EEC under the supervision of Notified Body Number 0120, SGS Yarsley International Certification Services Ltd, Portland Road, East Grimstead, W Sussex RH19 4ET.

Melbourne, 23 August 1999

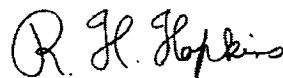

R. H. Hopkins  
Technical Director

On Behalf Of  
Metron Medical Australia Pty Ltd



The Metron Accusonic Plus Ultrasound Therapy Unit bears the above marking in accordance with the requirements of Council Directive 93/42/EEC.

Should you as the purchaser and/or user of this product wish to make any comment about the product or the manner in which it may be used our Authorised Representative within the European Union may be contacted as follows:

Metron Medical  
Attention: Mrs Sue Marks  
P.O. Box 5399  
Southend-On-Sea  
**ESSEX SS1 3RY UNITED KINGDOM**